

REFERENCE VIEW

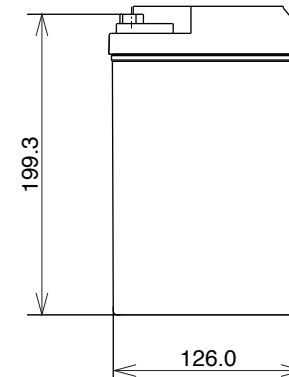
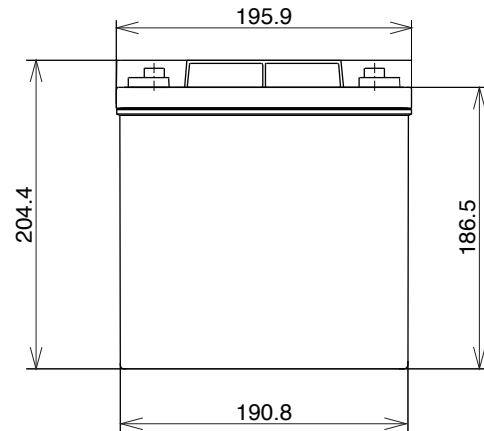

SCALE(尺度) 1:5	NAME(名称) DEEP CYCLE BATTERY
TOLERANCE(公差) REFER TO TOLERANCE LIST	
DATE(作成日)	TYPE(型式) PVX-420T
株式会社 電菱	DWG.NO.(図番) DC-P-001